

# סכמת צירים

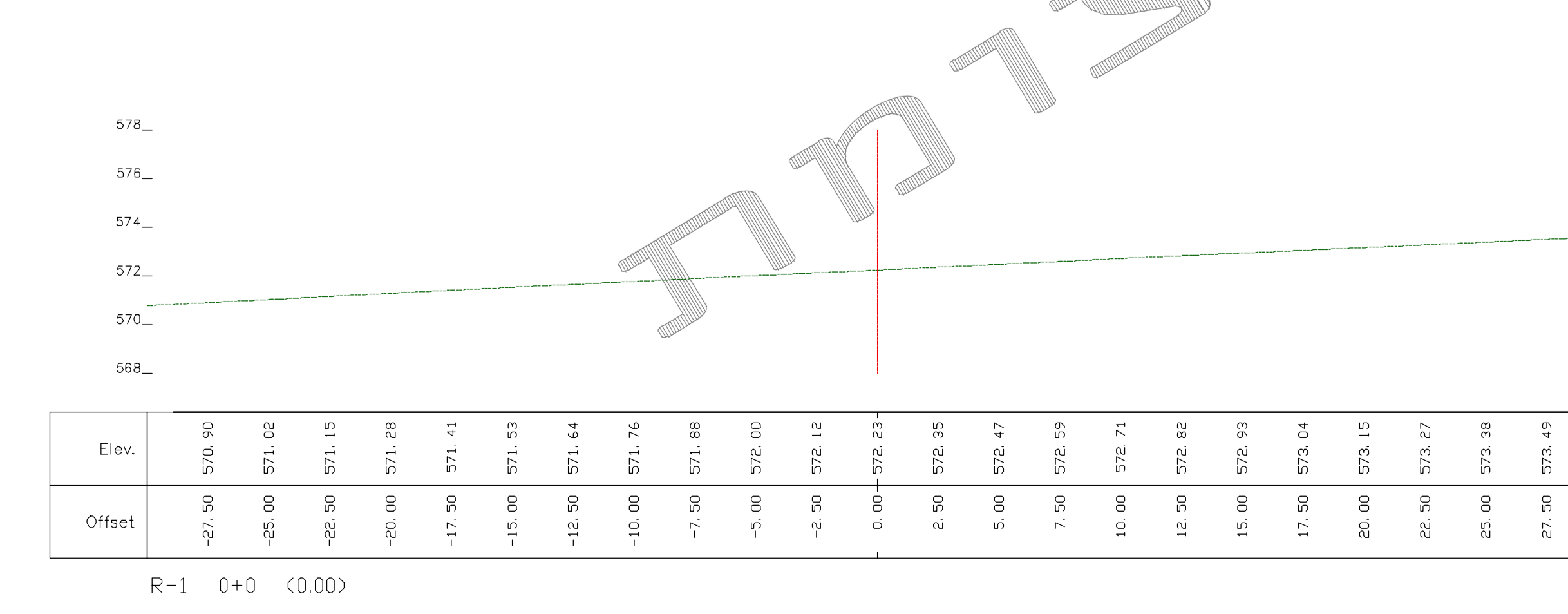
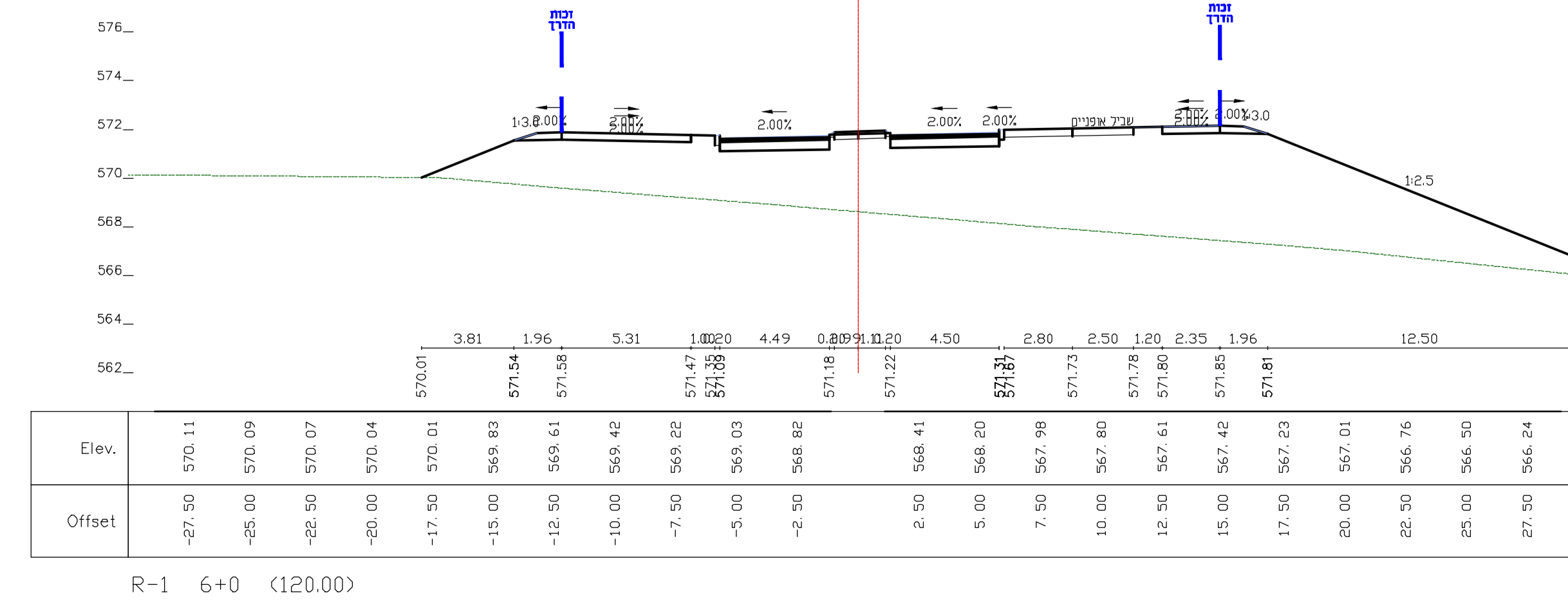
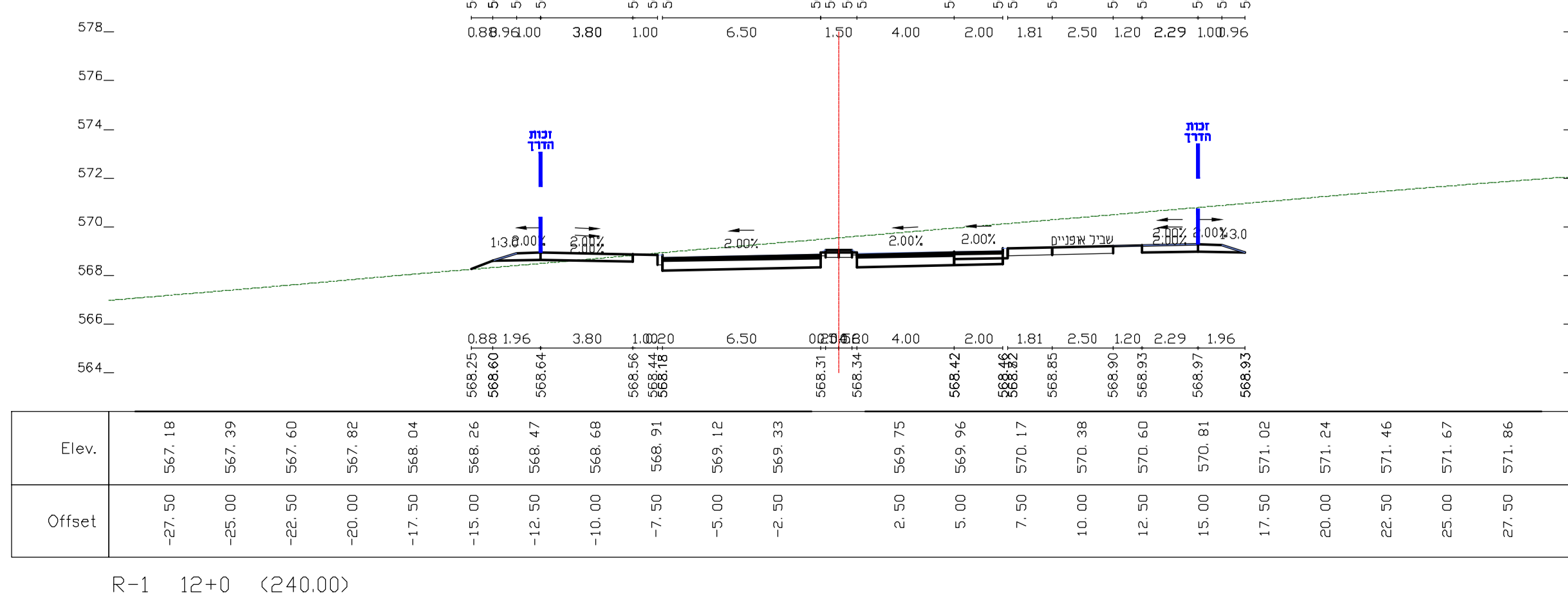
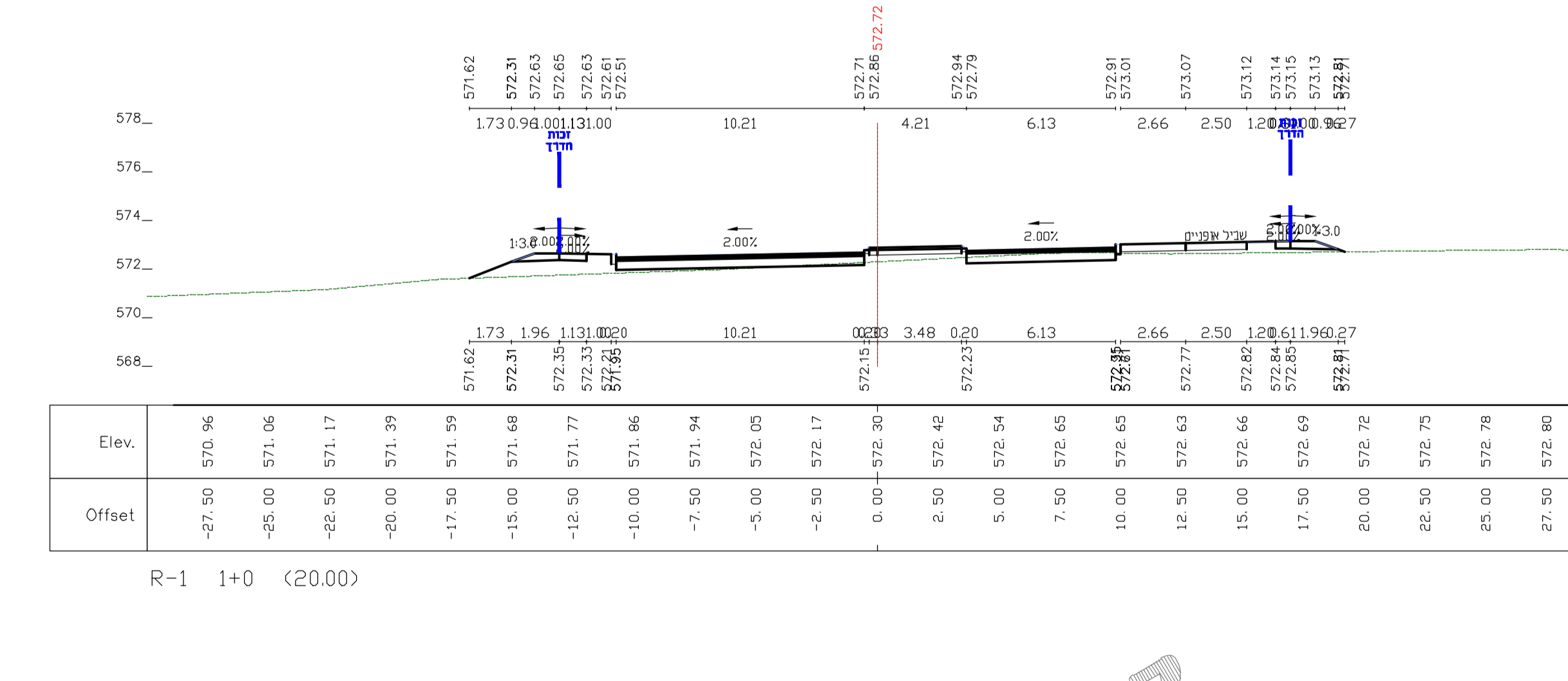
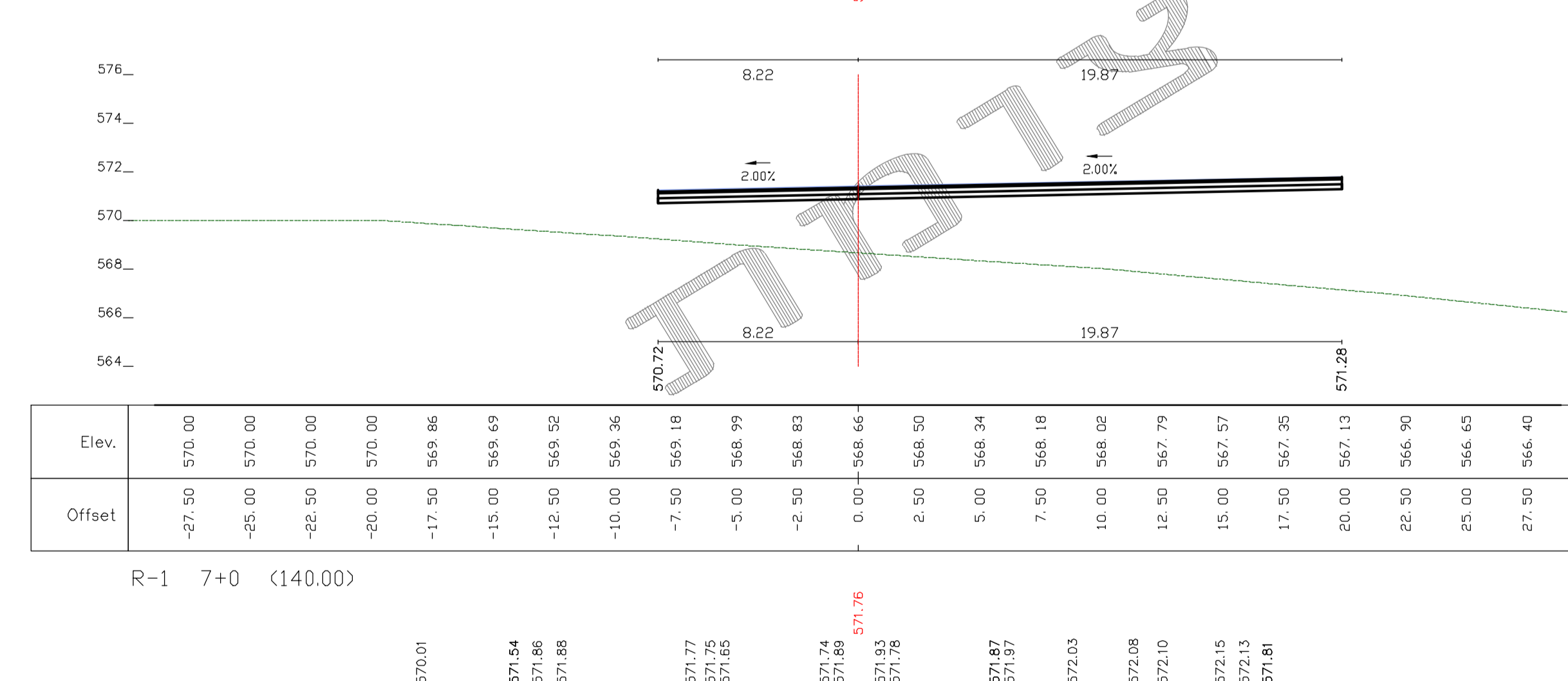
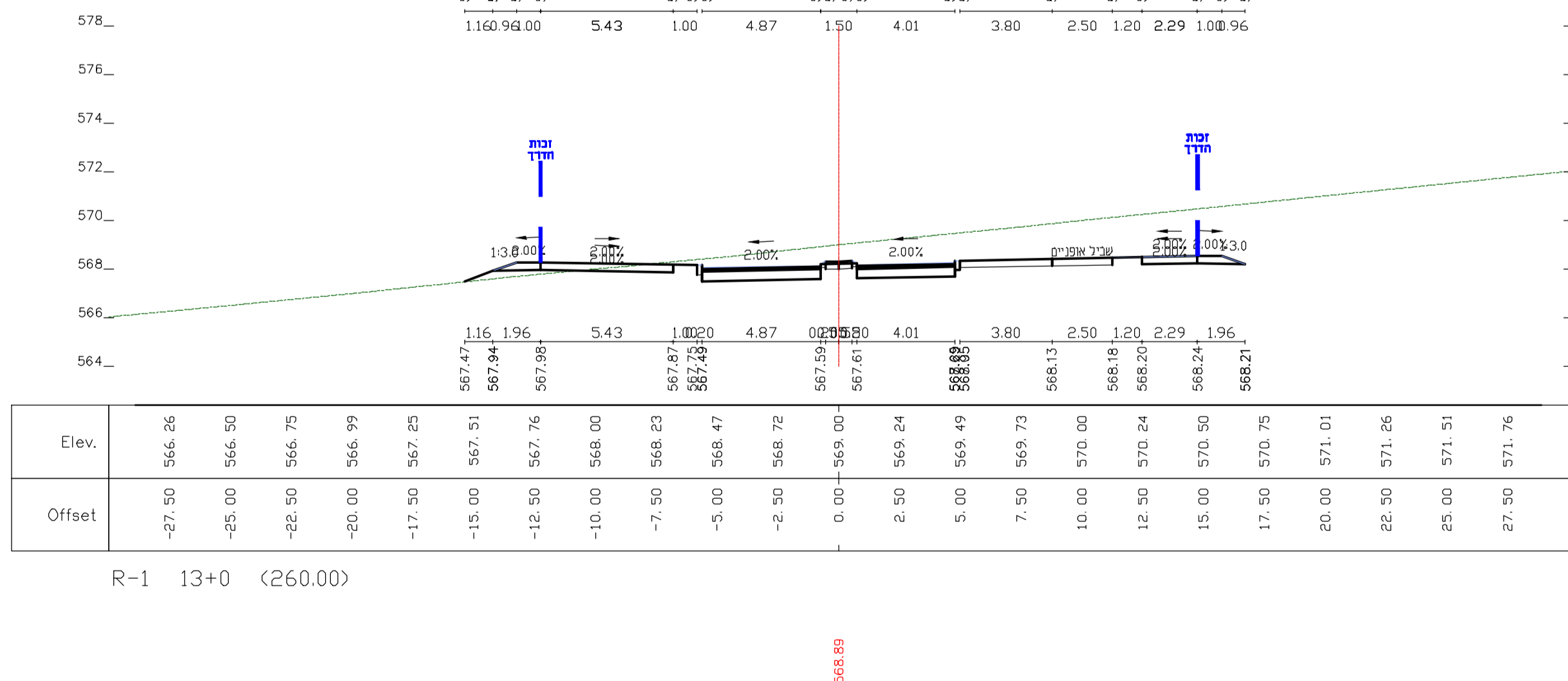
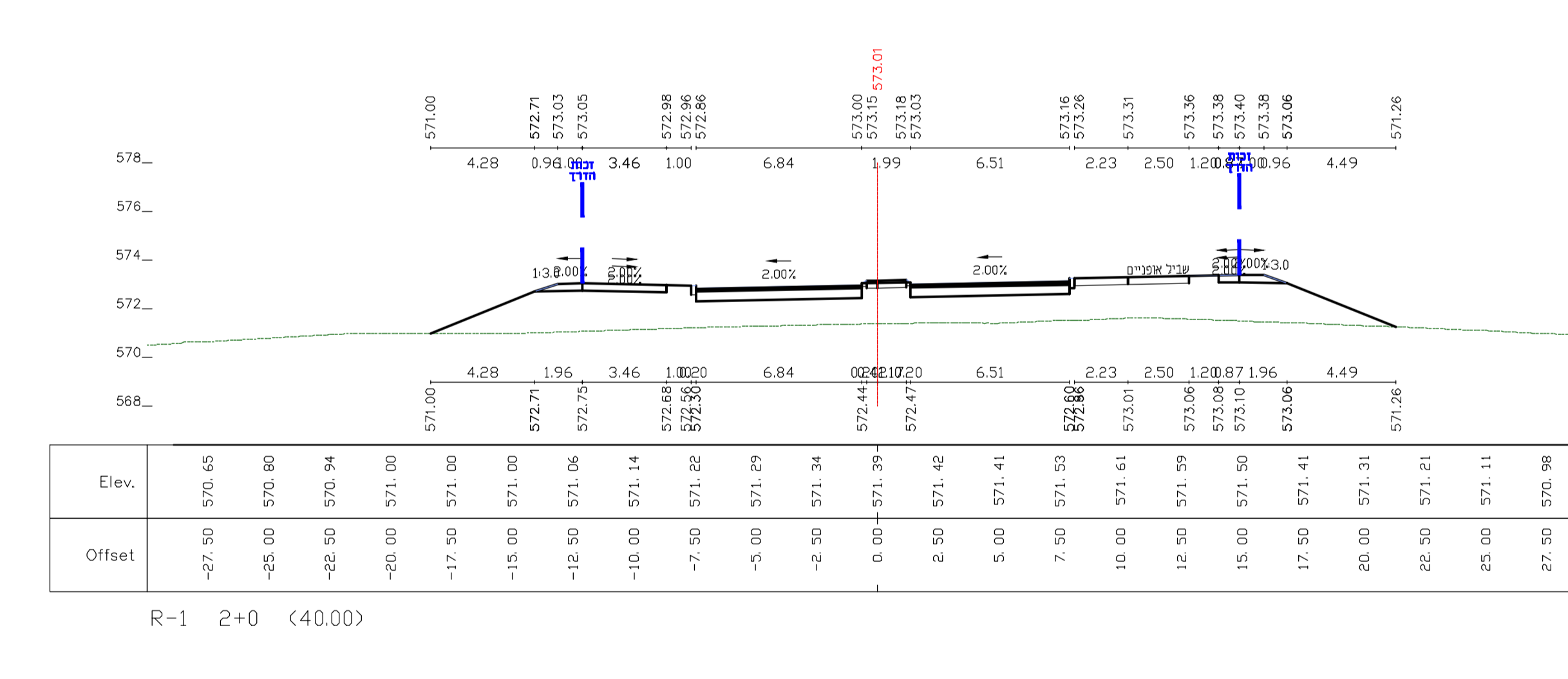
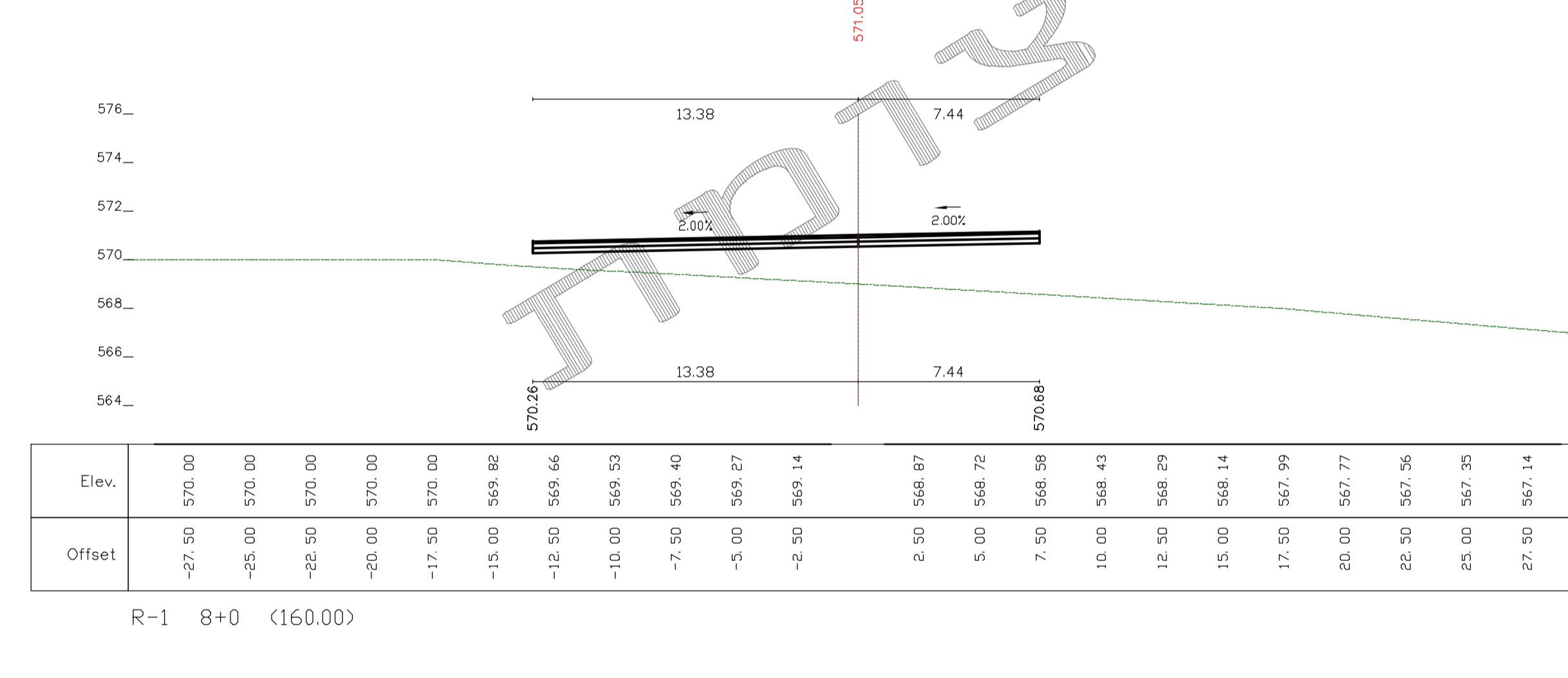
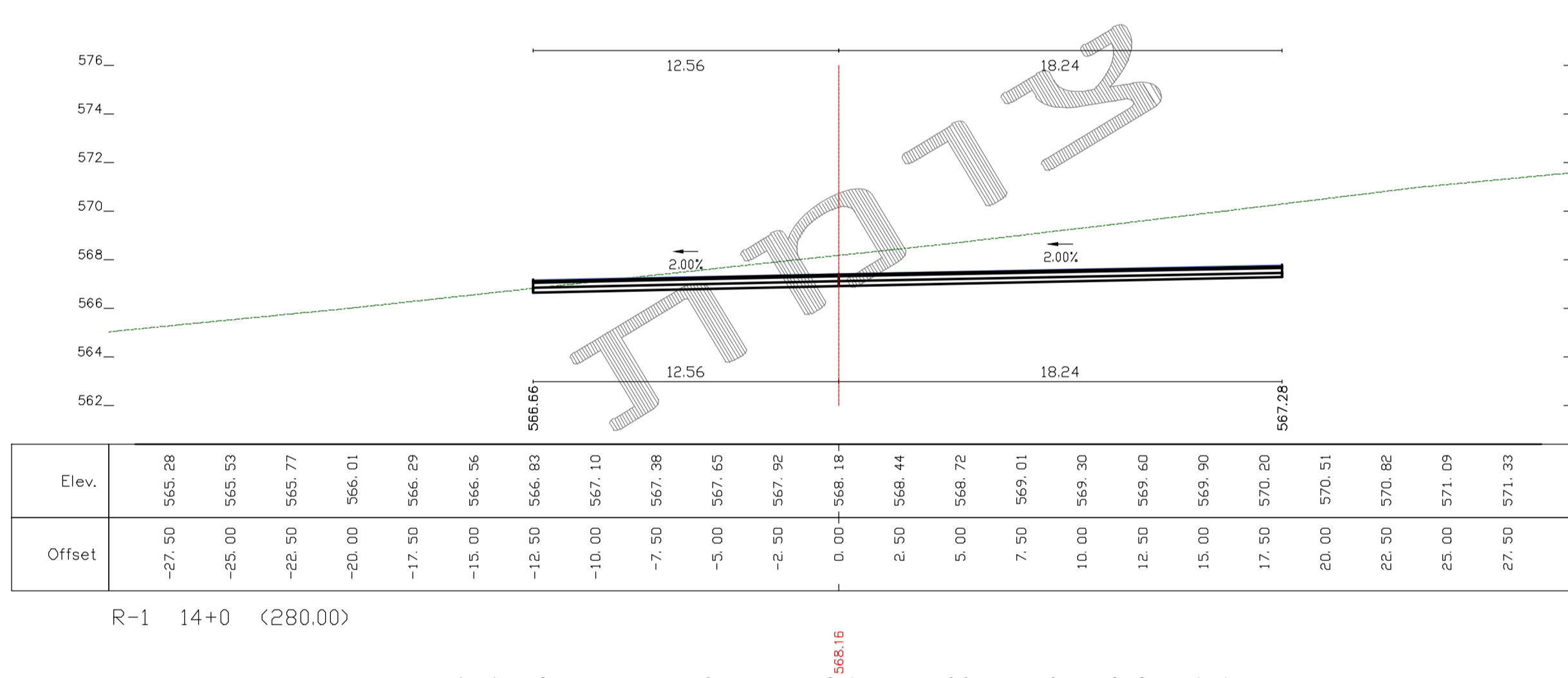
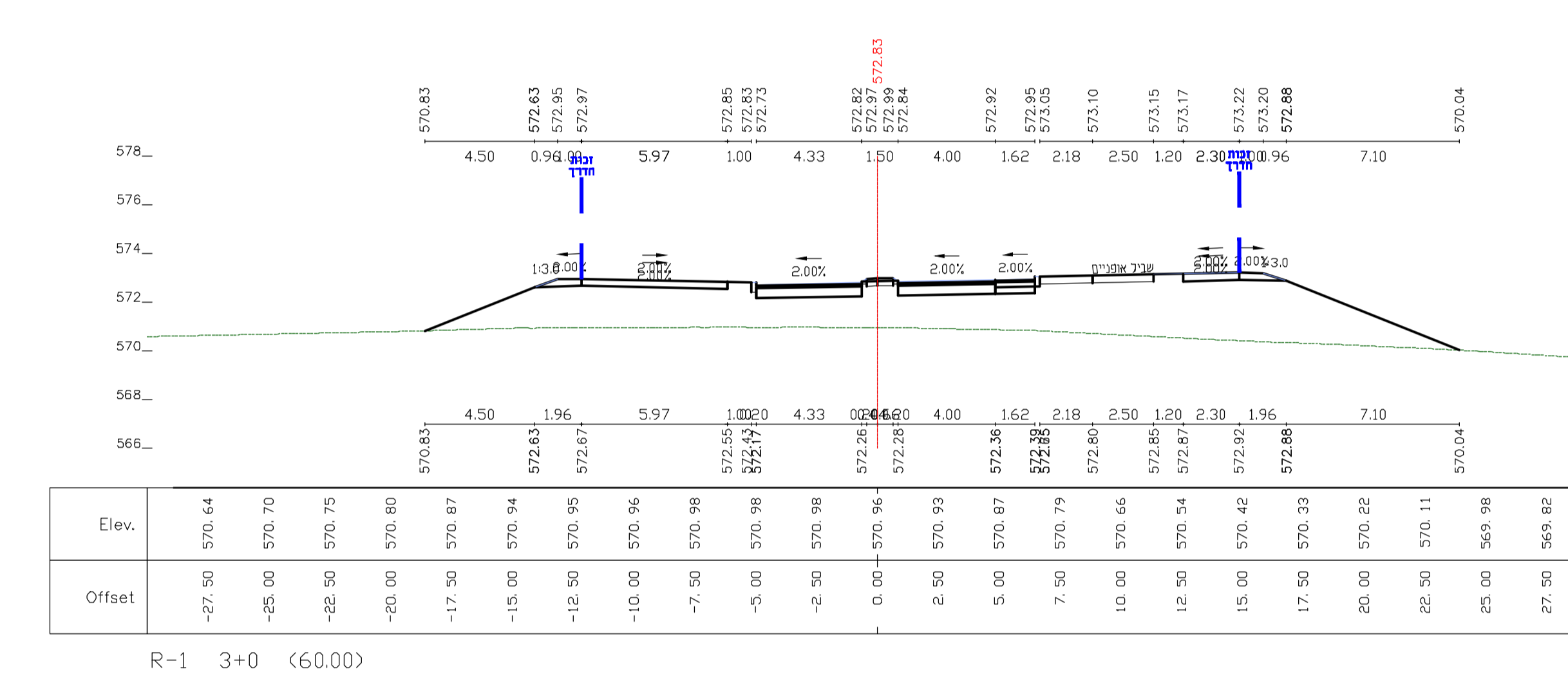
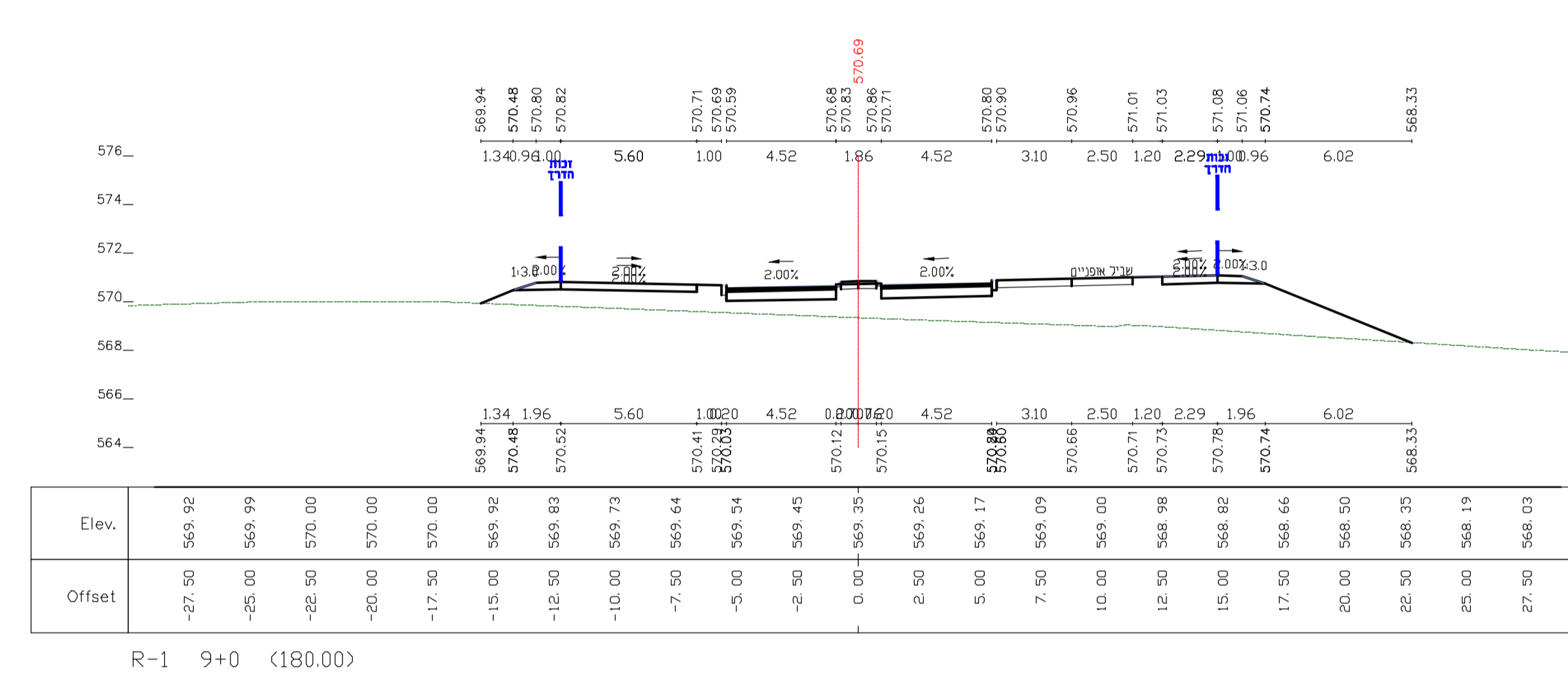
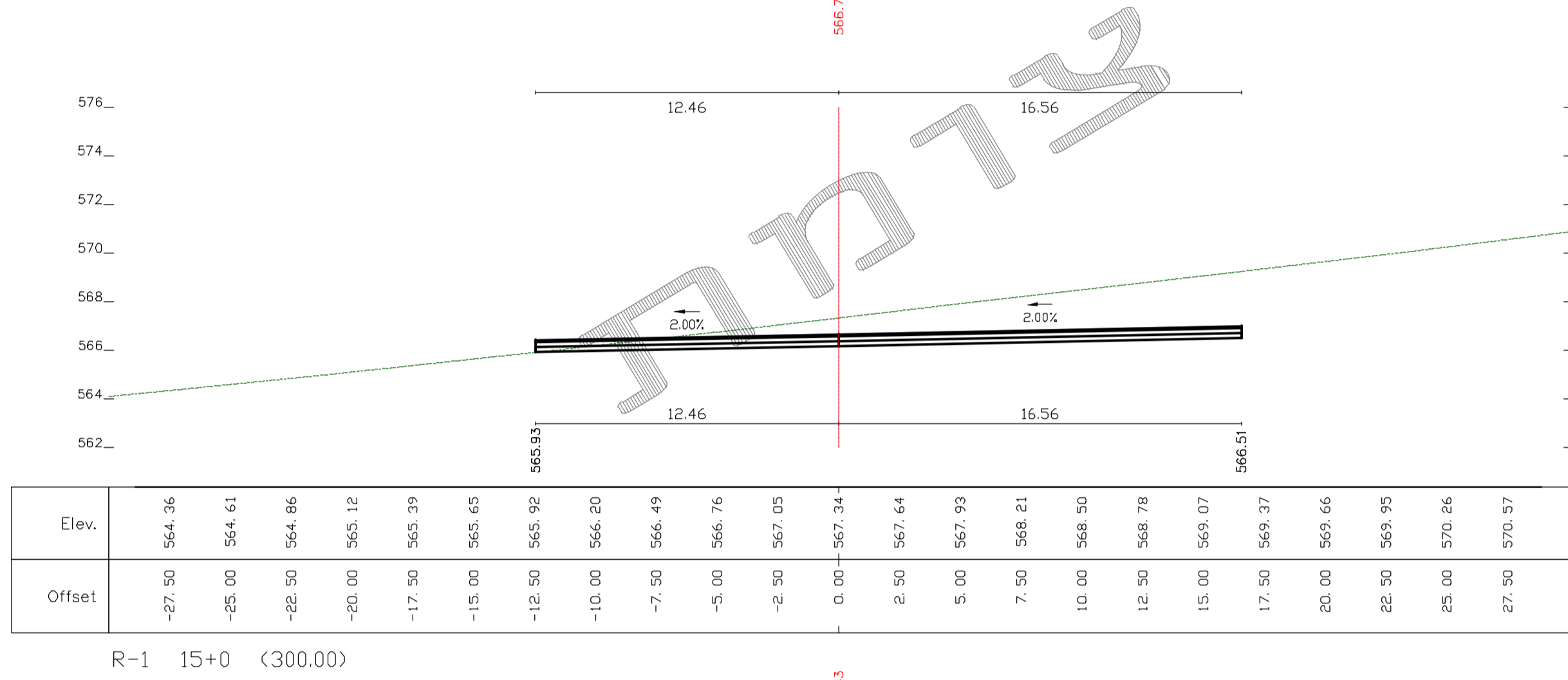
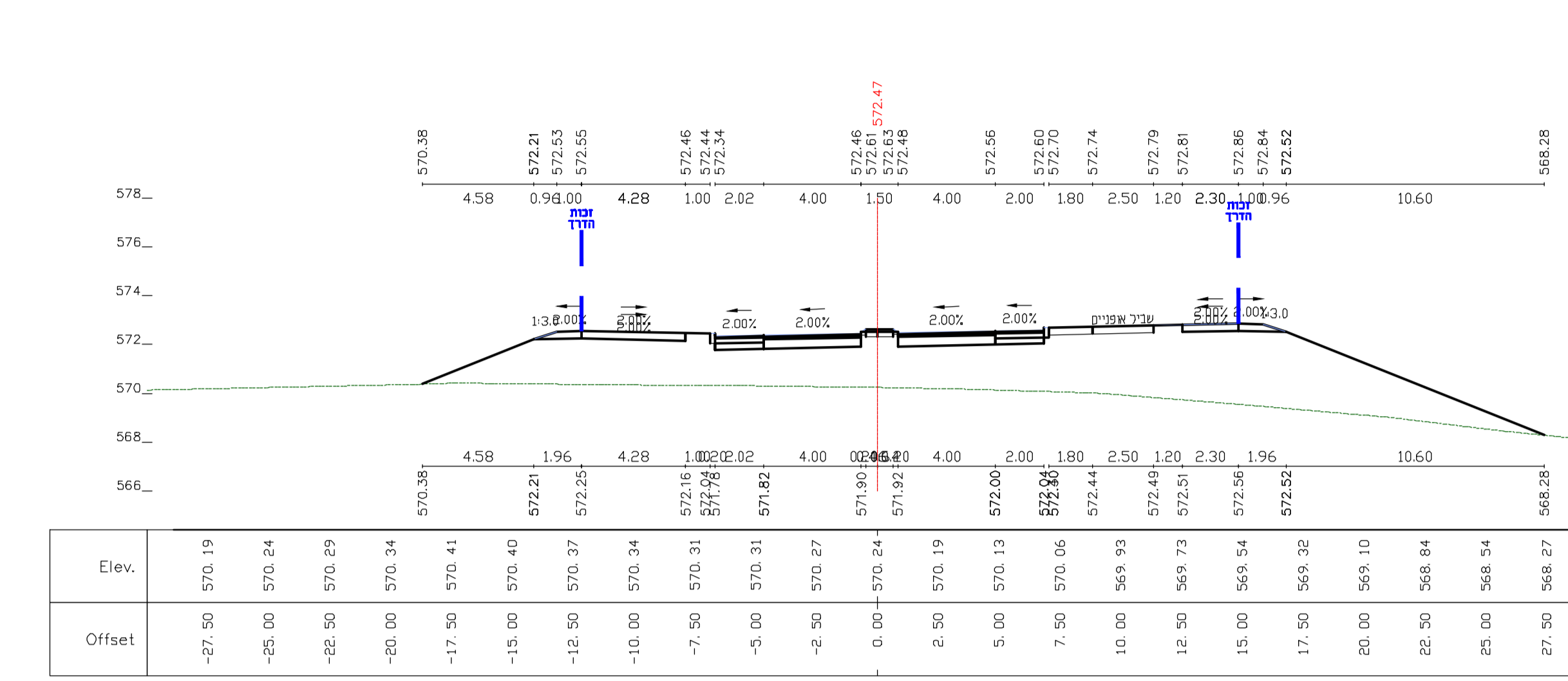
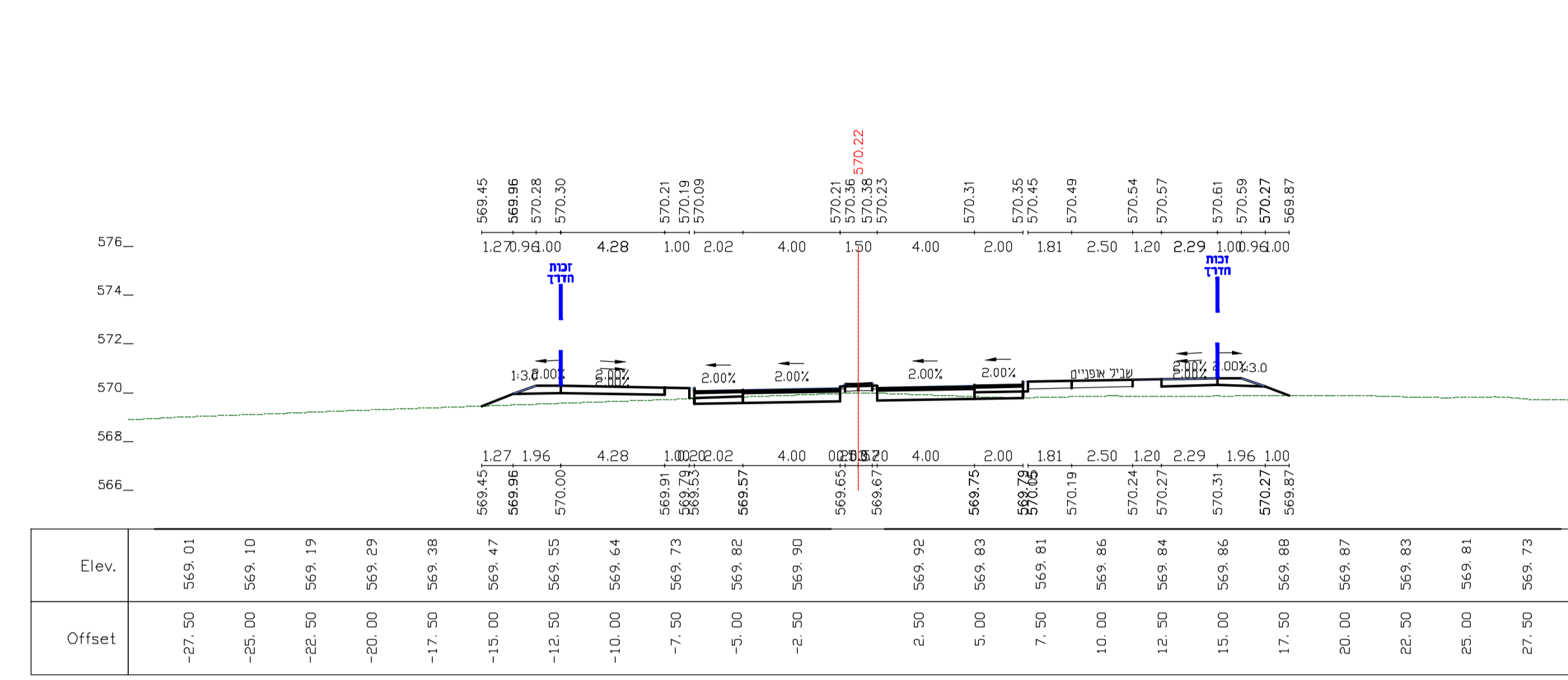
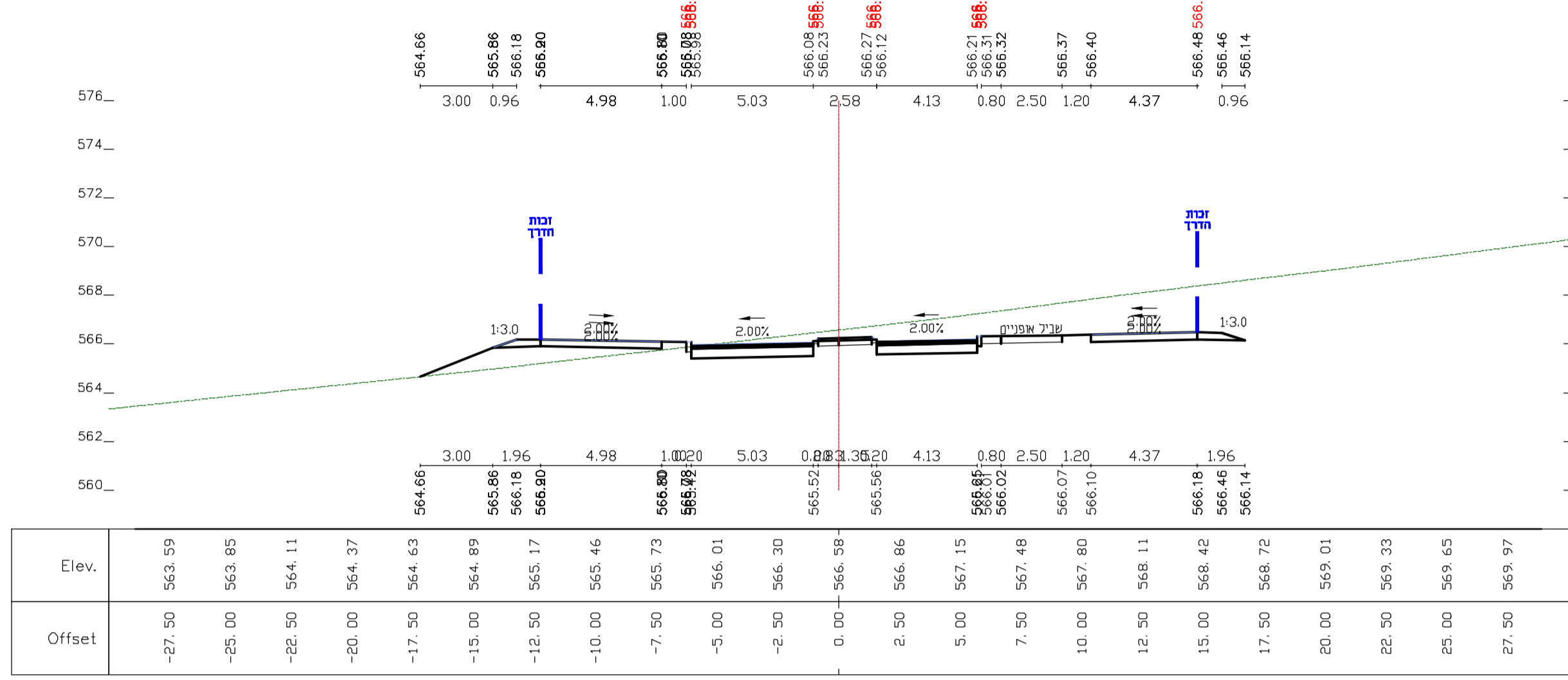
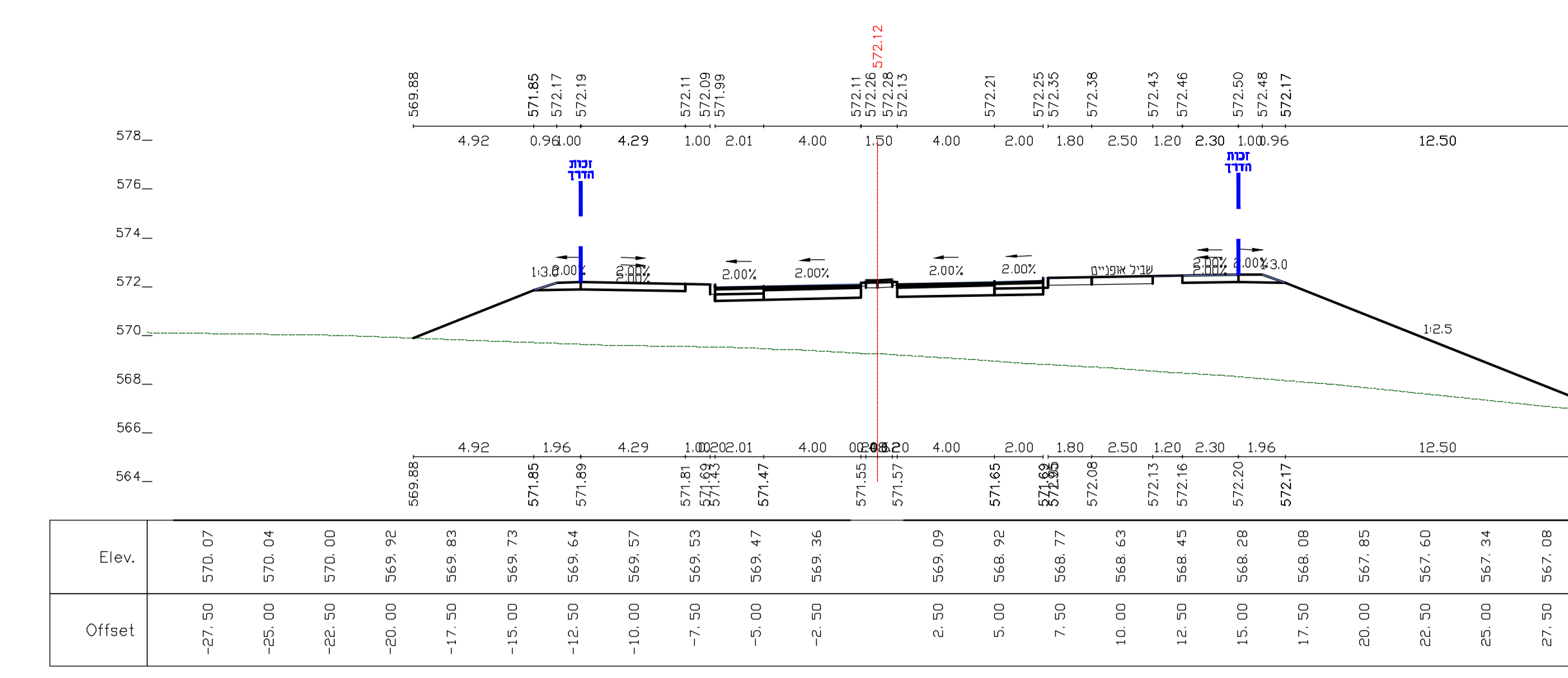
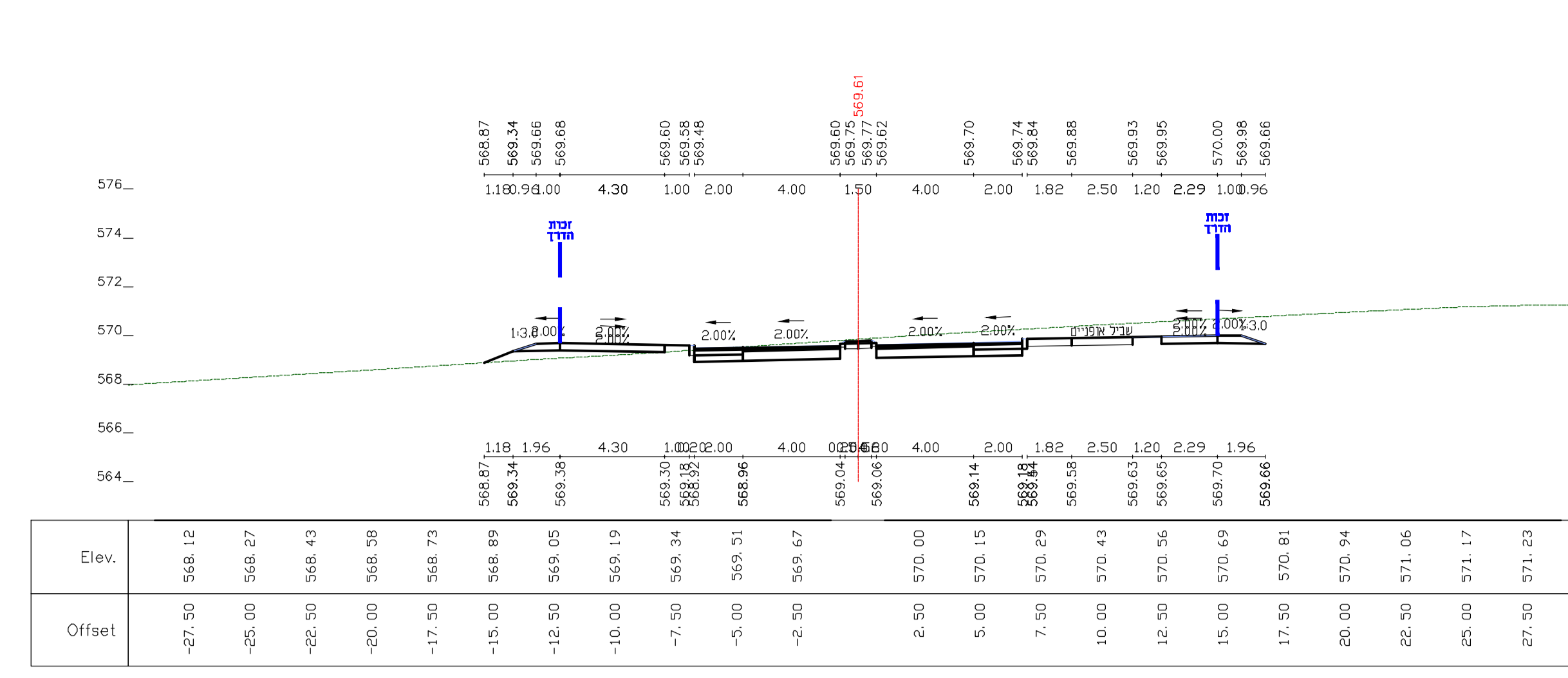
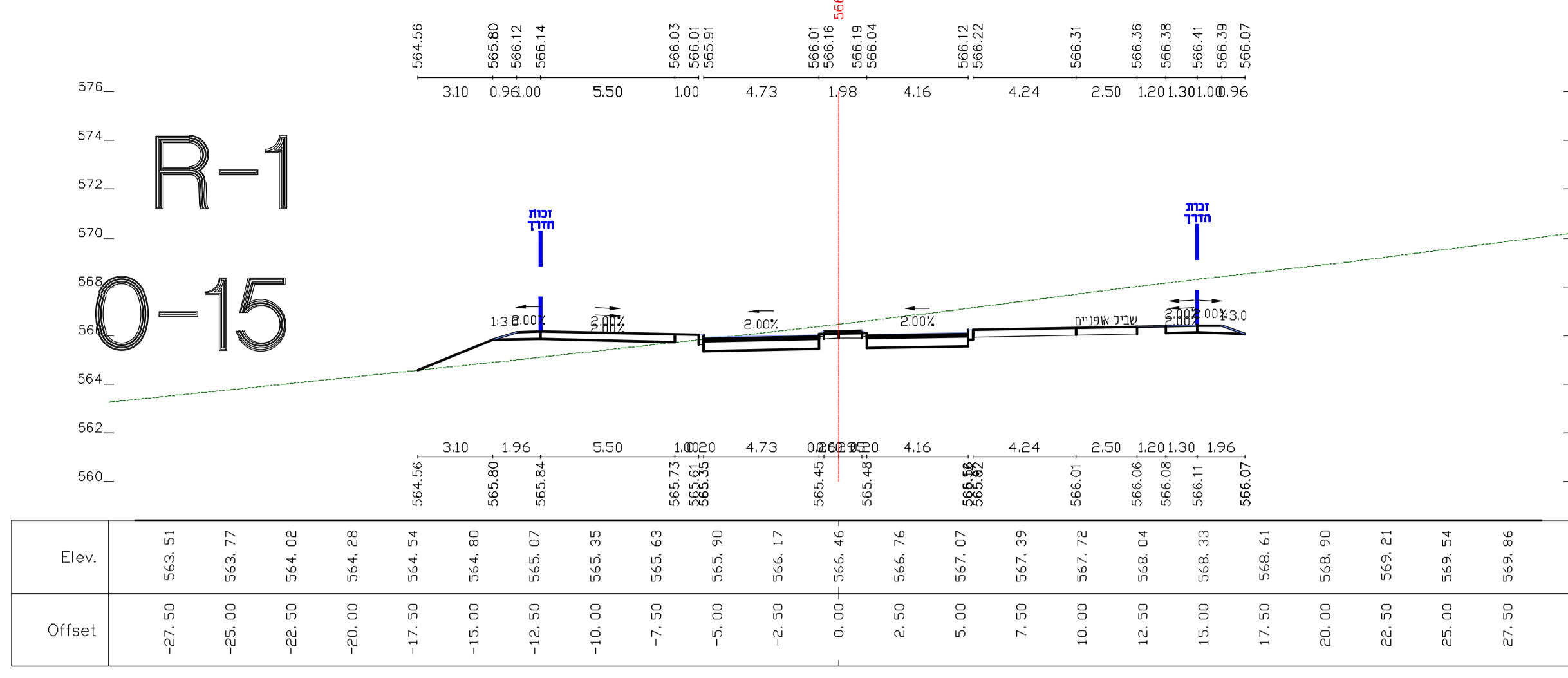
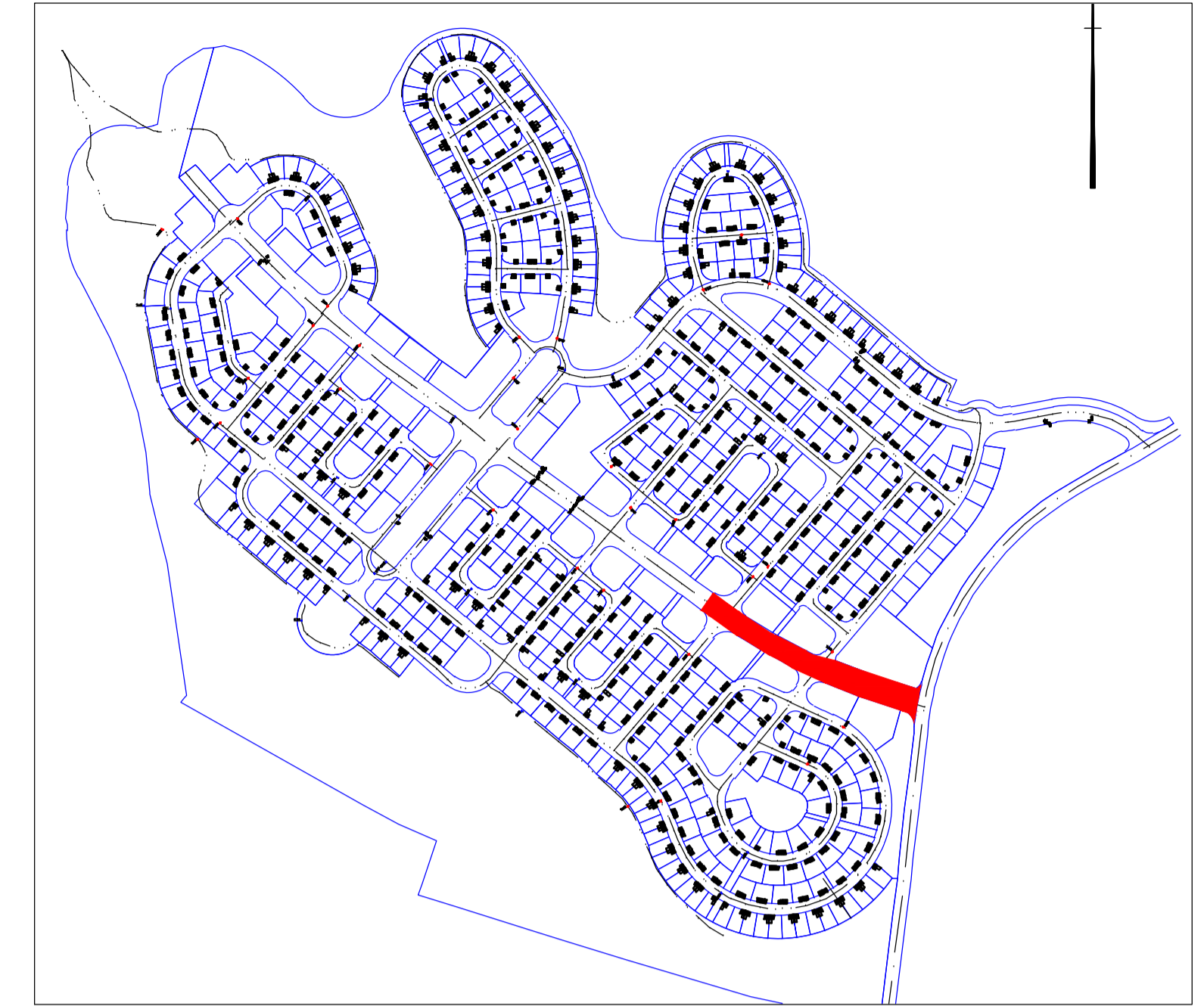

**הערות לתוכנית**  
 -כמוצב של מיכיל ישי כבוצע וריקור כמוצב קיים בשמוט של 12.5  
 -בחומר מאושר מיכילי בכבישים  
 -במקרה של חמירה בחתום המגרשים יש