

Typical schemes of laying the gas pipeline in the trench

Without crossing communications
(trench depth max 2300 mm)

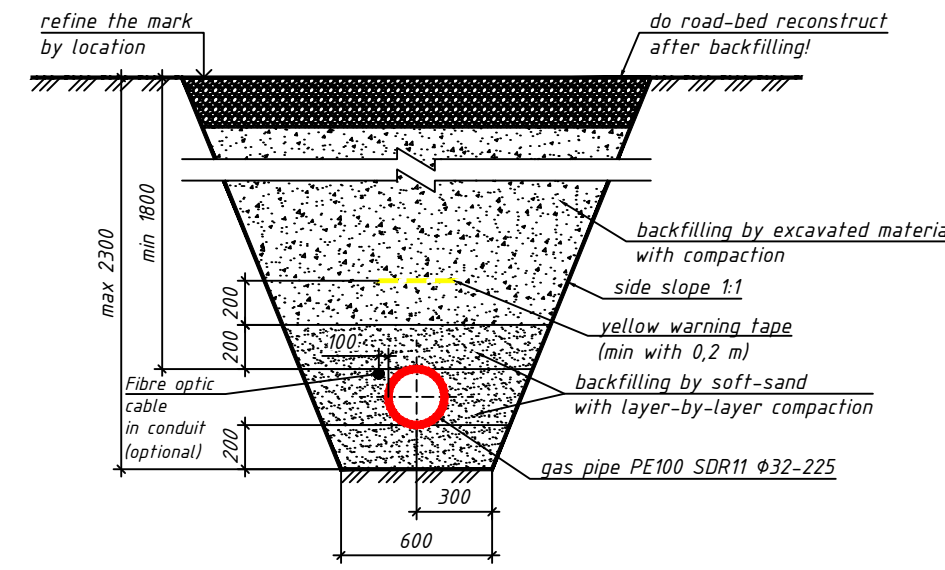

Without crossing communications
(trench depth max 4000 mm)

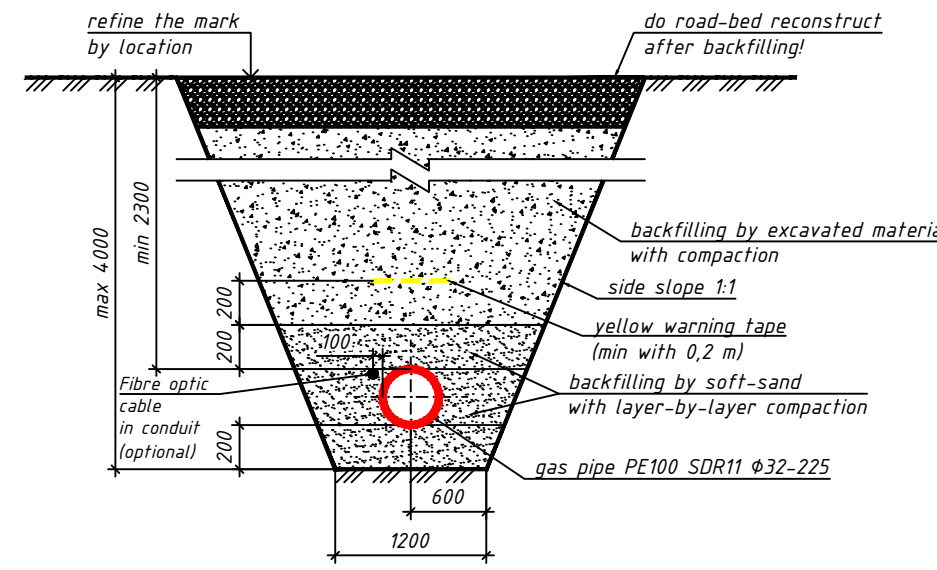

Gas pipe crossing water pipe
under it

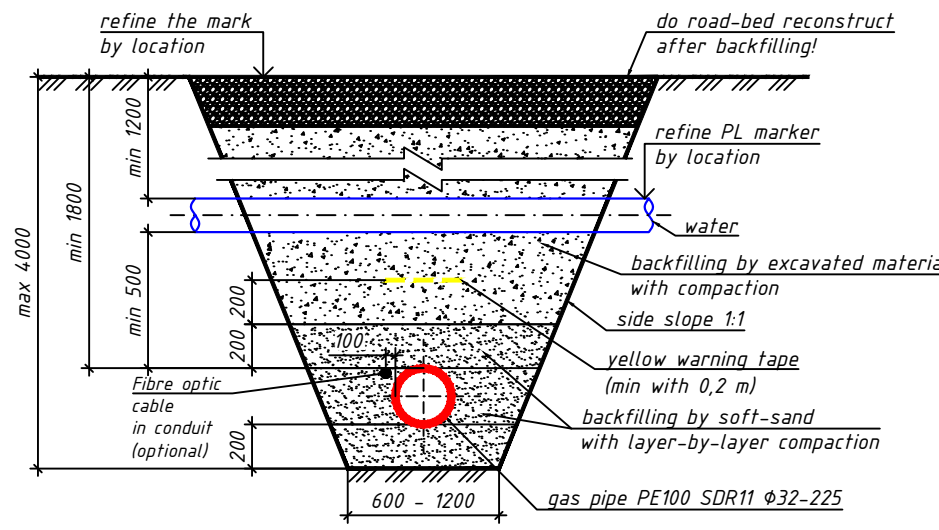

Gas pipe crossing drainage pipe
under it

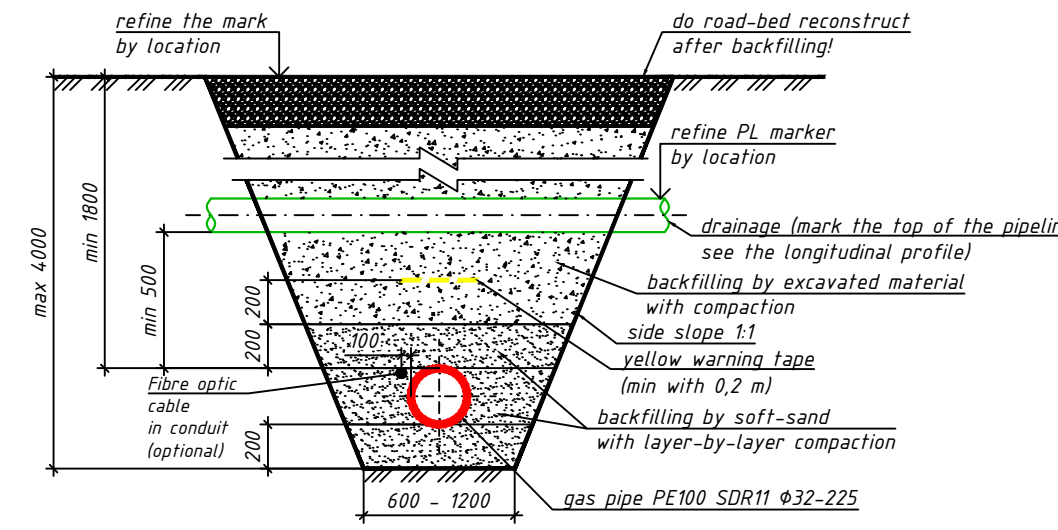

Gas pipe crossing sewage pipe
under it

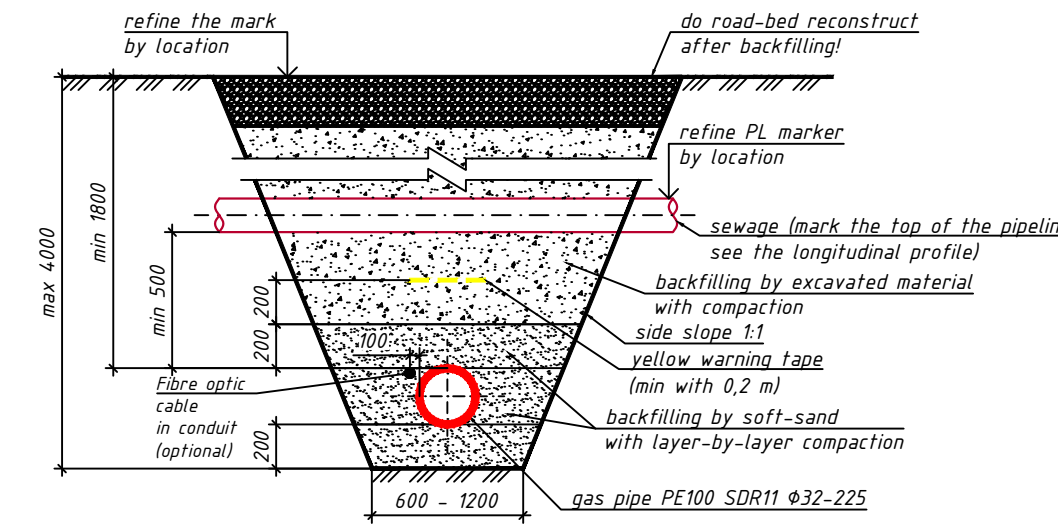

Gas pipe crossing irrigation pipe
under it

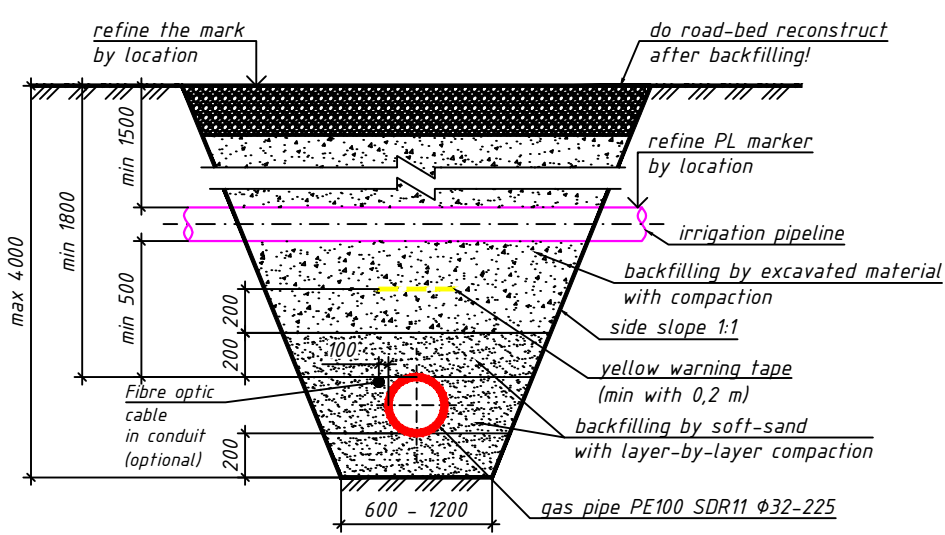

Gas pipe crossing sewage,
drainage, irrigation or water
pipes

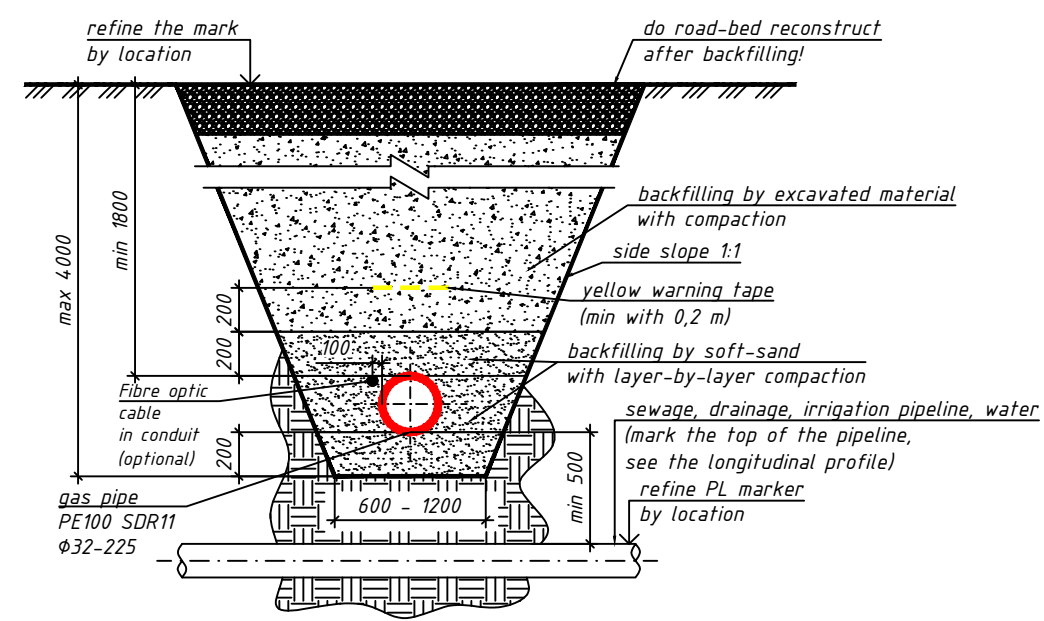

Gas pipe crossing electrical light
that goes along the sidewalk

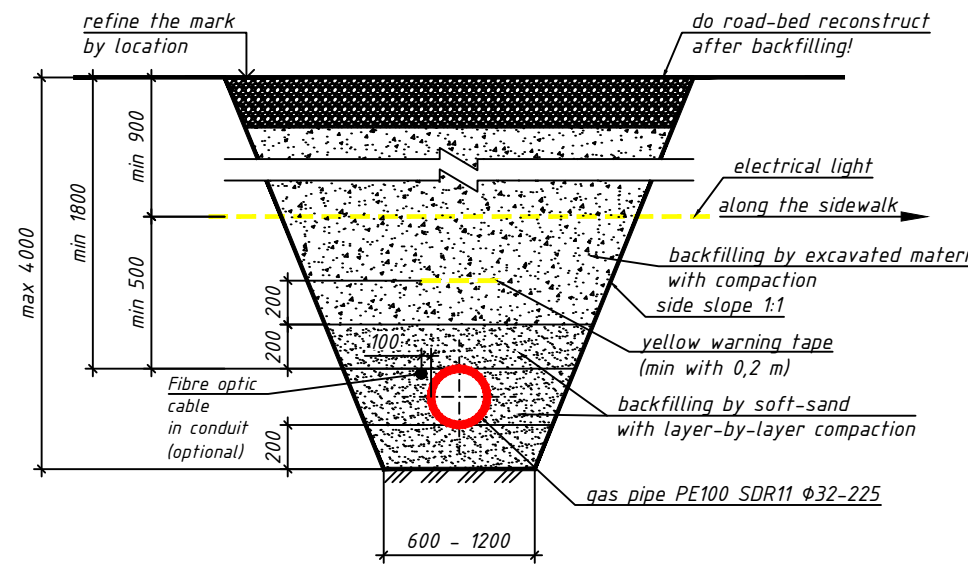

Gas pipe crossing communication lines
that goes along the sidewalk

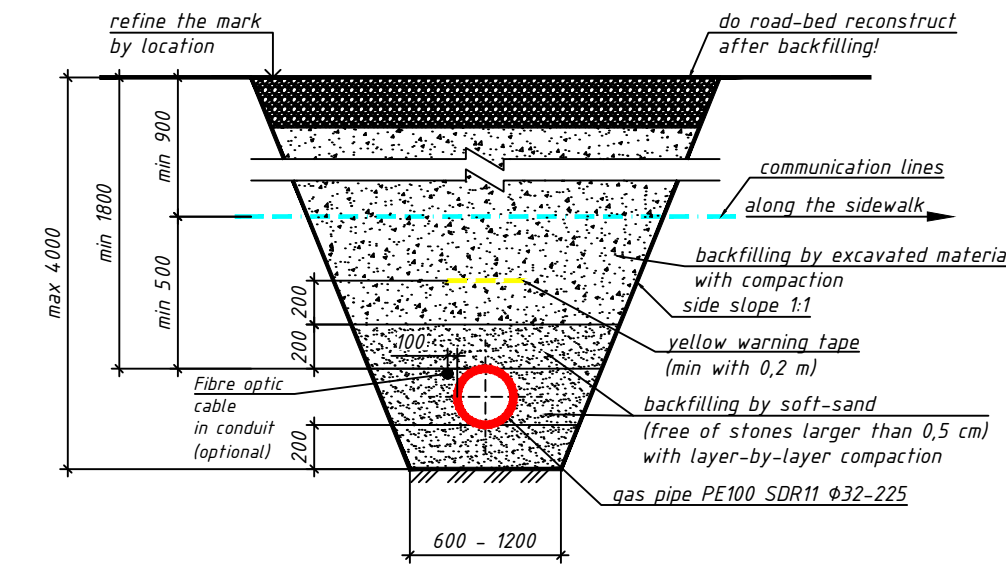

Gas pipe crossing electrical line
that goes along the sidewalk

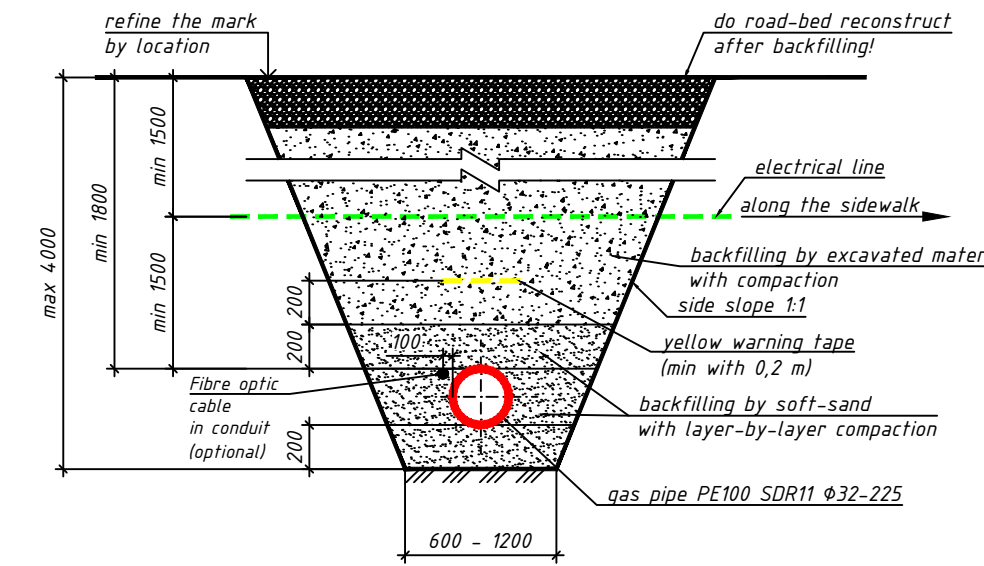

Gas pipe crossing electrical light
that goes along the road

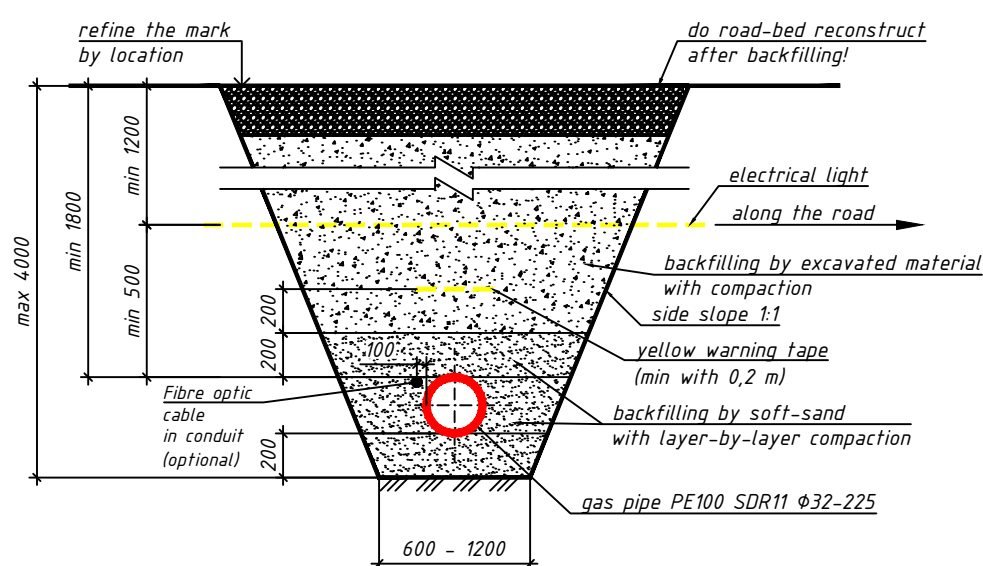

Gas pipe crossing communication lines
that goes along the road

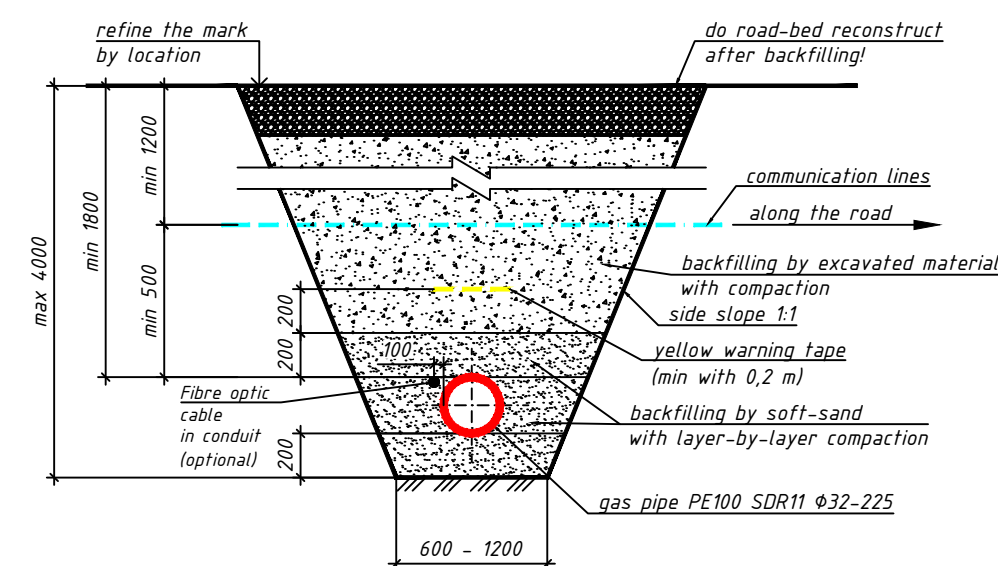

Gas pipe crossing electrical line
that goes along the road

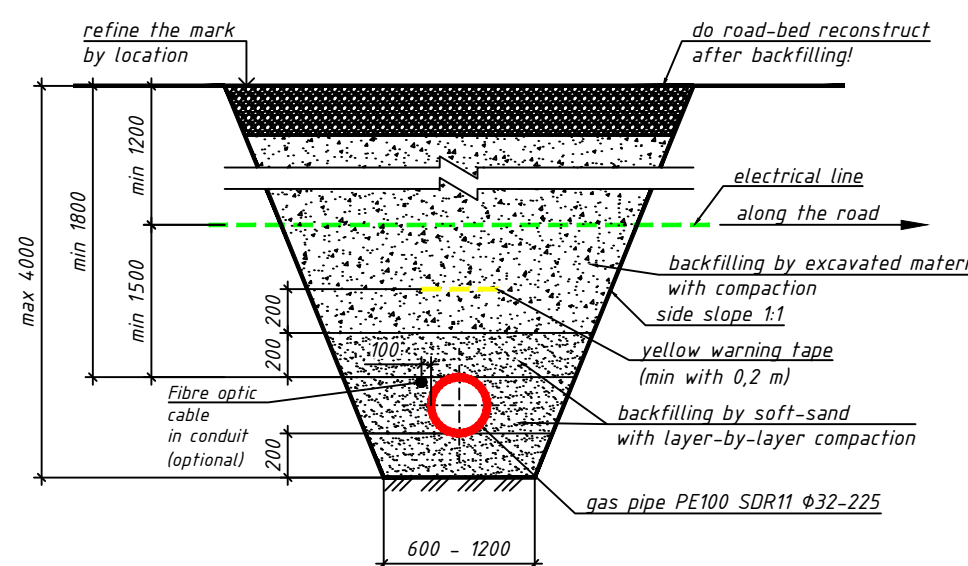

Trench with vertical slopes and
prefabricated panels

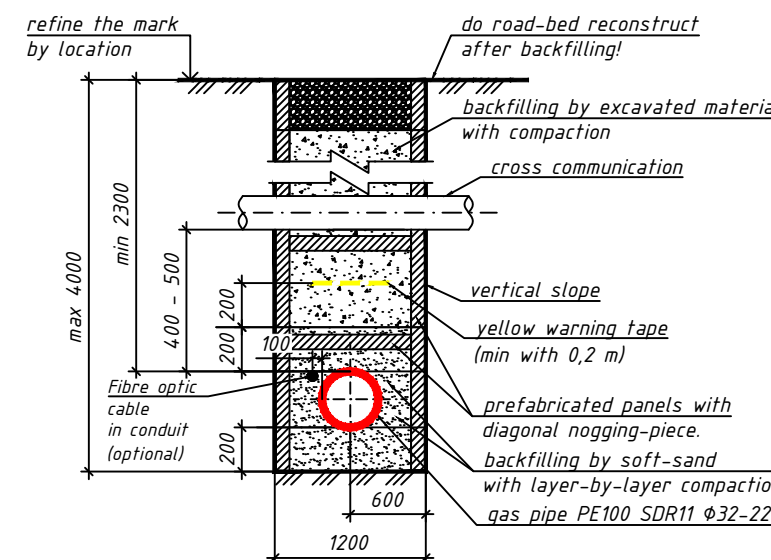

Covering control tube

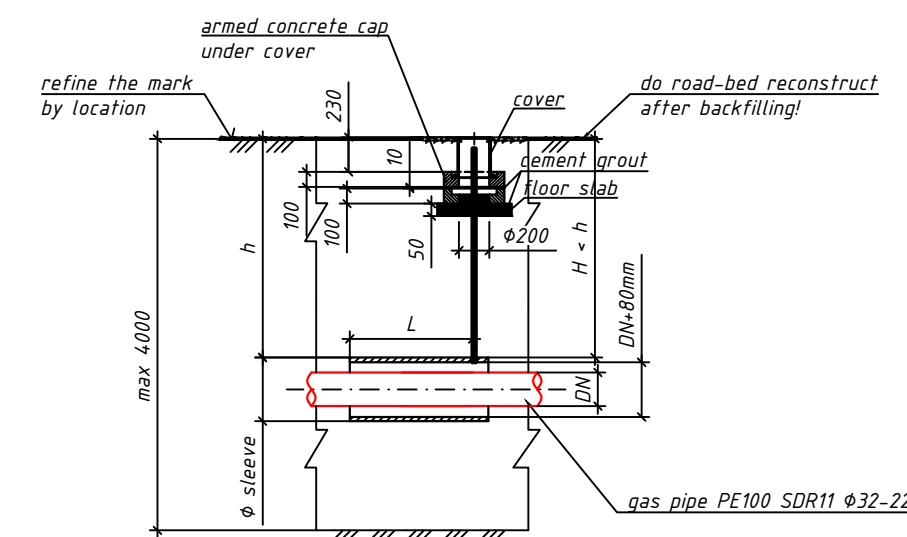

-	-	-	-	-	-
-	-	-	-	-	-
-	-	-	-	-	-
-	-	-	-	-	-

Rev.	Date	Description	Revision	BY	CHK	APPD
------	------	-------------	----------	----	-----	------

Design Company:
BIM LEADERS LTD.
St. Nofar 32 Yavne 8120732 Israel

Client Company:
NEGEV NATURAL GAS
7 Masada St. Besser Building 4 Bnei Brak, POB 47, 5126112
Tel:03-5228508 Fax:03-5662521 Email:office@negevgas.co.il

Title:
**NATURAL GAS DISTRIBUTION NETWORK
ROVA 12 ARAD**
Typical schemes of laying the gas pipeline in the trench

Region/Area:
ROVA 12 ARAD

Proj. №:
-

Drawing №:
DAR-PLN-DSG-0101

Scale:
-

Date:	10.06.2021				
	Design Company Approvals			Client Company Approvals	
	Designed	Checked	Approved	Approved	Approved
Name:	A. Bukatchuk	O. Safaniuk	T. Gotsulenko	K. Sigron	Y. Leviel
Sign:					
Date:	10.06.2021	10.06.2021	10.06.2021	10.06.2021	10.06.2021